

# ARCHISTONE

# Conoscere, evolvere, sorprendere

Understand, evolve, surprise / Erkennen, weiterentwickeln, verblüffen  
Connaître, évoluer, surprendre / Conocer, evolucionar, sorprender

Osservare la natura per scoprirne l'inimitabile fascino e riproporne le più mutevoli tracce è per Cerdisa solo l'inizio di un percorso che trasforma un'intuizione in una gamma di prodotti dalle qualità tecniche performanti e dall'estetica sorprendente: una risposta concreta ed efficace alle esigenze dell'architettura contemporanea. Archistone è una collezione di pietre ceramiche che rinnova la bellezza delle pietre naturali interpretandone strutture e cromatismi, con prestazioni tecniche molto superiori. Modularità di formati, estrema stonalizzazione, variabilità di strutture e superfici per un utilizzo in interno ed esterno, a pavimento e a rivestimento, sono frutto di una ricerca che guarda al futuro: dove il nostro passato e la nostra storia si evolvono, contaminandosi di tecnologia, design e funzionalità.

Observing nature in order to understand its inimitable charm and recreate its most fleeting aspects is, for Cerdisa, just the beginning of a journey that transforms an intuition into a range of products with high-performance technical qualities and eye-catching aesthetics: a concrete and effective response to the requirements of contemporary architecture. Archistone is a collection of ceramic stones that emphasises the beauty of natural stones, interpreting their structures and colours with superior technical performances. The modular formats, broad colour range, variability of structures and surfaces for indoor and outdoor use, for flooring and coverings, are the product of research that focuses on the future: where our past and our history evolve, fusing with technology, design and functionality.

Die Natur beobachten, ihre unnachahmliche Faszination entdecken und ihre Mannigfaltigkeit wiedergeben: Diese Grundidee setzt Cerdisa in ein Produktprogramm um, das mit ausgezeichneten Leistungsmerkmalen und einer überraschenden Optik aufwartet. Eine konkrete, intelligente Lösung für die Anforderungen des zeitgemäßen Bauens. Archistone ist eine keramische Steinkollektion, die an die Ästhetik des Natursteins anknüpft. Sie interpretiert seine Strukturen und Farben und bietet zugleich deutlich bessere Leistungsmerkmale. Modulare Formate, extreme Abstufungen, vielfältige Strukturen und Oberflächen für Boden- und Wandbeläge für Innen- und Außenbereiche sind das Resultat einer zukunftsweisenden Entwicklungstätigkeit, basierend auf unserer Tradition und Geschichte in Verbindung mit Technik, Design und Funktionalität.

Observer la nature pour en découvrir le charme inimitable et en offrir les traces les plus mouvantes : pour Cerdisa, ce n'est là que le début d'un parcours où une intuition se transforme en une gamme de produits à la technicité performante et à l'esthétique surprenante, une réponse concrète et efficace aux exigences de l'architecture contemporaine. Archistone est une collection de pierres céramiques où la beauté des pierres naturelles est renouvelée grâce à une interprétation de leur structure et de leurs couleurs, offrant des performances techniques bien supérieures. Modularité des formats, extrême variation des nuances, variabilité des structures et des surfaces pour une utilisation en intérieur et en extérieur, pour les sols et les murs : tels sont les fruits d'une recherche tournée vers l'avenir, là où notre passé et notre histoire se transforment, s'imprégnant de technologie, de design et de fonctionnalité.

Observar la naturaleza para descubrir su inimitable encanto y proponer sus huellas más variables para Cerdisa no es más que el comienzo de un proceso que transforma una intuición en una gama de productos de excelentes cualidades técnicas y de sorprendente estética: una respuesta concreta y eficaz a las necesidades de la arquitectura contemporánea. Archistone es una colección de piedras cerámicas que recrea la belleza de las piedras naturales interpretando su estructura y sus colores, con prestaciones técnicas muy superiores. Formatos modulares, extraordinaria gradación cromática, estructuras y superficies varias para la aplicación en espacios interiores y exteriores, para pavimento y revestimiento, que son fruto de una investigación que mira hacia el futuro: donde nuestro pasado y nuestra historia evolucionan, incorporando progreso tecnológico, diseño y funcionalidad.

# colori, finiture e formati

Colours, finishes, formats / Farben, Oberflächen und grösse  
Les couleurs, les finitions et les format / Colores, acabados y tamaño



GRAFITE

DARKSTONE



LIMESTONE BIANCO

LIGHTSTONE

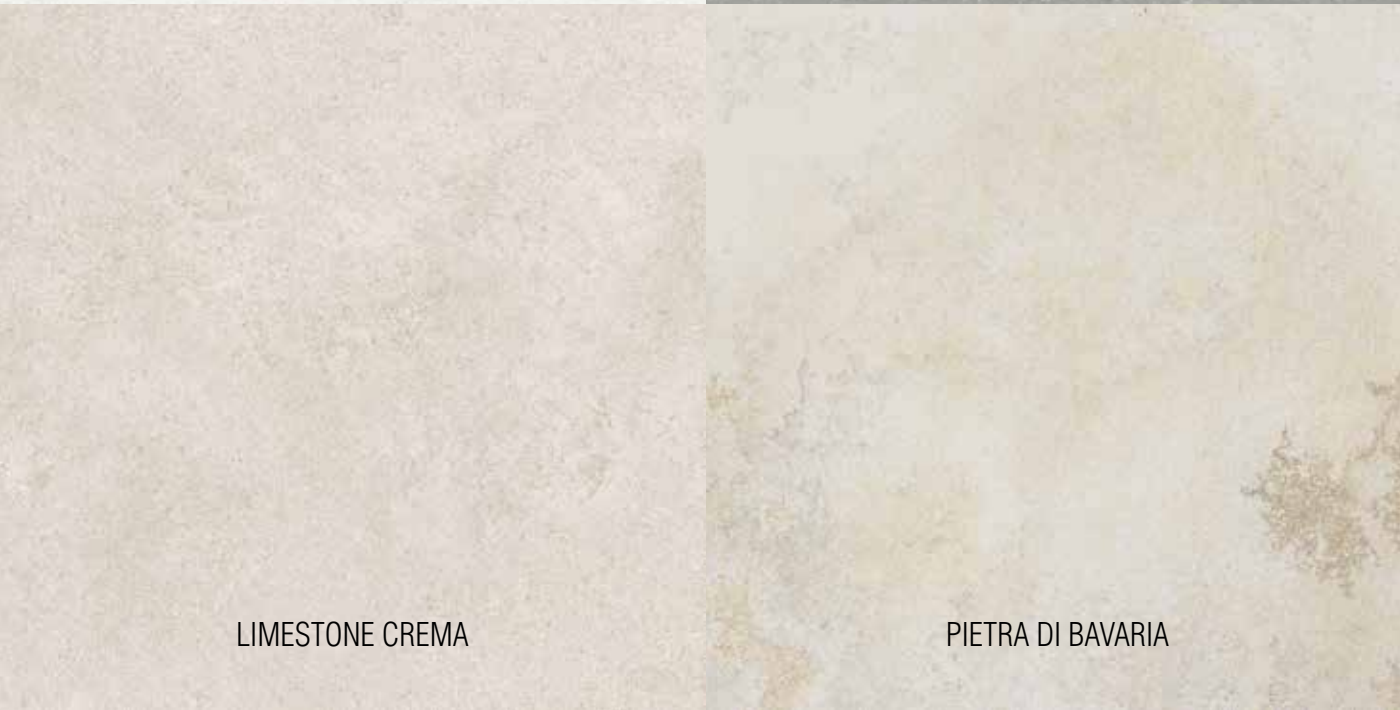

LIMESTONE CREMA

PIETRA DI BAVARIA

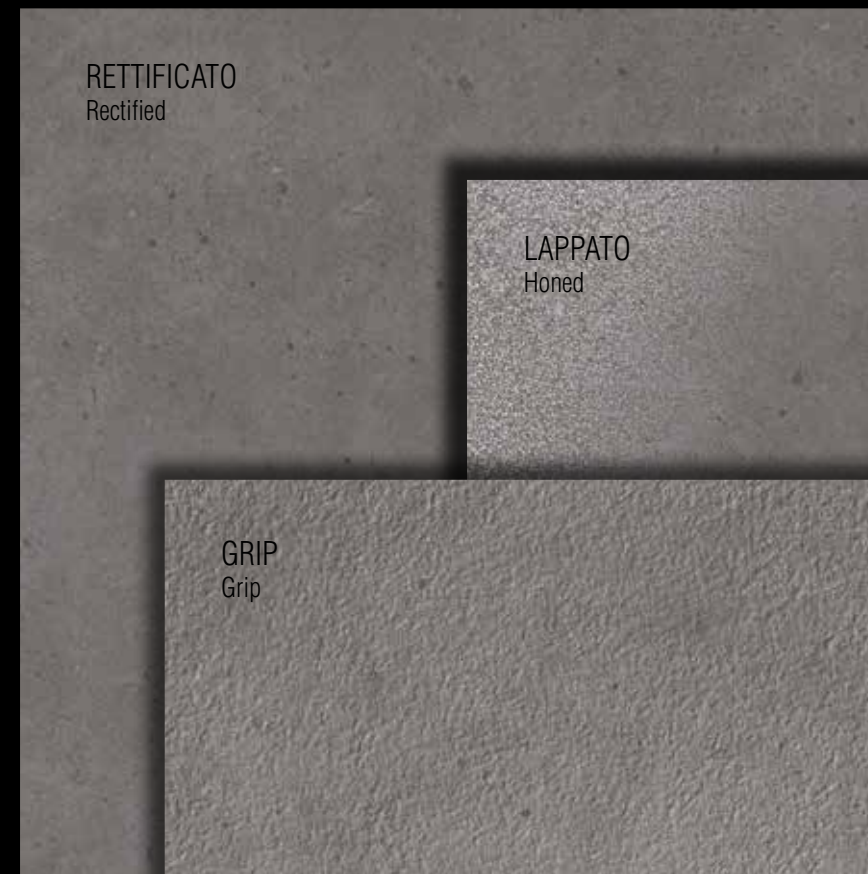

RETTIFICATO  
Rectified

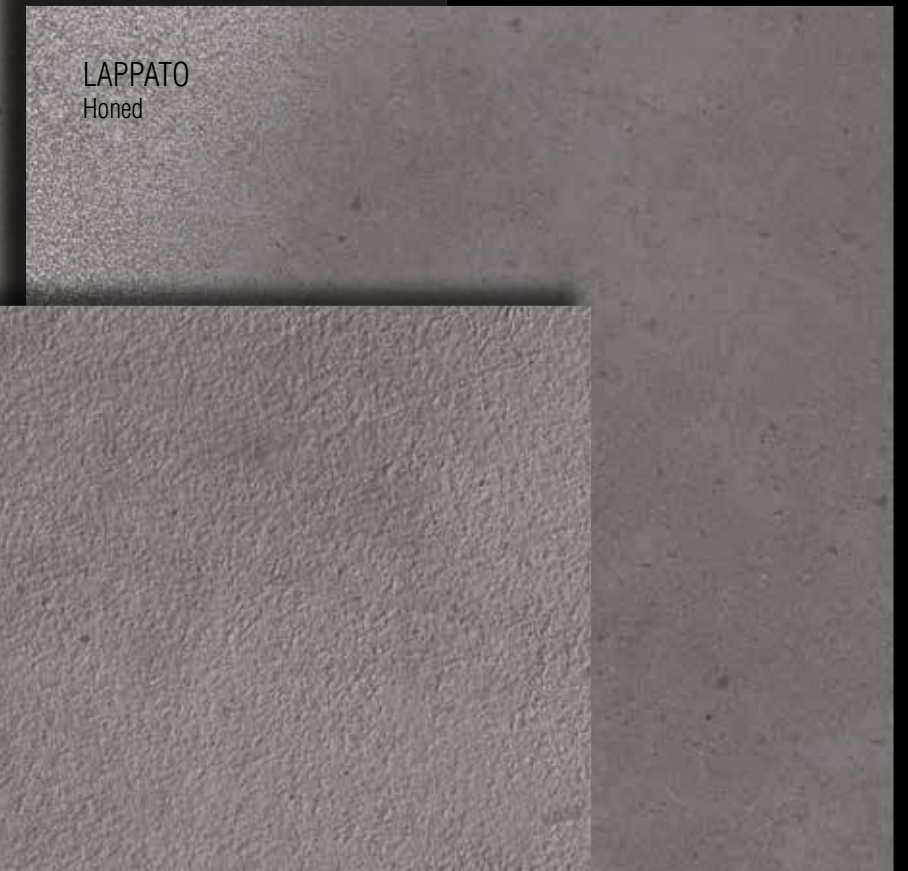

LAPPATO  
Honed



GRIP  
Grip



60x120  
24"x48"



30x120  
12"x48"



60x60  
24"x24"



30x60  
12"x24"



30x30  
12"x12"



esterno/outdoor:  
Grafite Rett. Grip 60x60  
Mosaico 3D Grafite Rett. 30x60  
interno/indoor:  
Grafite Rett. Lapp. 60x60

Grafite



Pizzo Grafite 30x60  
Trama Grafite 30x60  
Grafite Lapp. 60x60

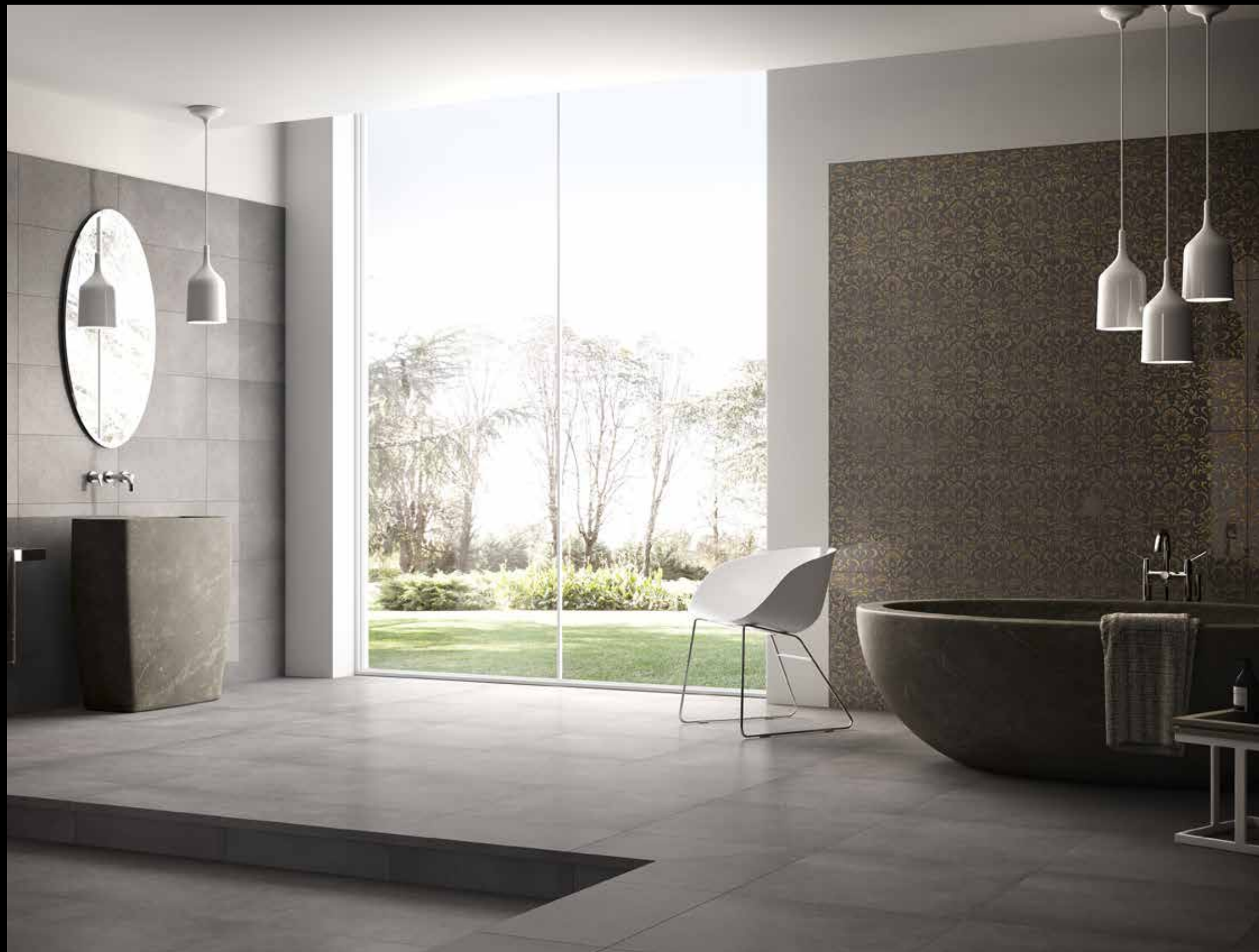

Damascato Grafite 30x60  
Grafite Lapp. 30x60  
Grafite Rett. 60x60







Limestone Bianco Rett. Grip. 60x60

Limestone Bianco Lapp. 60x60  
Mosaico 3D Limestone Bianco 30x60









Damascato Limestone Crema 30x60  
Limestone Crema Lapp. 60x60

Pizzo Limestone Crema 30x60  
Trama Limestone Crema 30x60  
Limestone Crema Rett. 60x60







CIRCULAR ROAD  
CITY RP  
CLOVELLY  
COOCEE BEACH  
NEW YORK CITY  
COLLINS ST WEST  
DARLING POINT  
DENHAM ST BOUND  
DOLLS POINT  
DOUBLE BAY  
DOVER HEIGHTS  
CENTRAL STATION  
ELIZABETH BAY  
ERSKINEVILLE  
EXPRESS  
PIERS STREET  
FLOWER AND SUN ST  
FALL IN STREET  
GAP  
LIB  
HIGH



esterno/outdoor:  
Pietra di Bavaria Rett. Grip 60x60  
Pietra di Bavaria Rett. Grip 30x60  
Pietra di Bavaria Rett. Grip 30x30  
interno/indoor:  
Pietra di Bavaria Rett. Lapp. 60x60

interno/indoor:  
Pietra di Bavaria Rett. Lapp. 60x60  
esterno/outdoor:  
Pietra di Bavaria Rett. Grip 60x60  
Pietra di Bavaria Rett. Grip 30x60  
Pietra di Bavaria Rett. Grip 30x60





Darkstone Rett. Grip 60x60



Darkstone Lapp. 60x60







Mosaico 3D Lightstone Rett. 30x60

Mosaico 3D Lightstone Rett. 30x60  
Lightstone Rett. 60x60

# ARCHISTONE

Gres fine porcellanato Bla UGL EN 14411 / Fine porcelain stoneware / Feinsteinzeug / Grès cérame fin / Gres fino porcelánico



**PENDULUM TEST BS 7976**  
 Grip R10 A+B > 0,60 dry / > 0,60 wet  
 Grip R11 A+B+C > 0,60 dry / > 0,60 wet  
 Grip R10 A+B > 36 dry / < 25 wet  
 Grip R11 A+B+C > 36 dry / > 36 wet

60x120 / 30x120 / 60x60 / 30x60 / 30x30 - 24"x48" / 12"x48" / 24"x24" / 12"x24" / 12"x12"

Formati / Sizes / Grösse / Format / Tamaño:

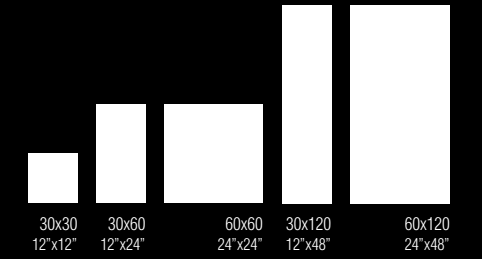

	Classement				
	U	P	E	C	Gel
60x120 Nat./Grip/Lapp.	U4	P3	E3	C2	S
30x120 Nat./Grip/Lapp.	U4	P3	E3	C2	S
60x60 Nat./Grip/Lapp.	U4	P4+	E3	C2	S
30x60 Nat./Grip/Lapp.	U4	P4	E3	C2	S
30x30 Nat./Grip/Lapp.	U4	P4+	E3	C2	S

GRAFITE

LIMESTONE BIANCO

LIMESTONE CREMA

DARKSTONE

LIGHTSTONE

PIETRA DI BAVARIA

**R9**  
**NATURALE**  
 NATURAL / NATUR / NATURELLE / NATURAL

**LAPPATO**  
 HONED / LEICHT POLIERT / POLIADOUCI / PULIDO

**R11 A+B+C**  
**GRIP**  
 GRIP / GRIFFIGE OBERFLÄCHE / GRIP / ANTIDESLIZANTE

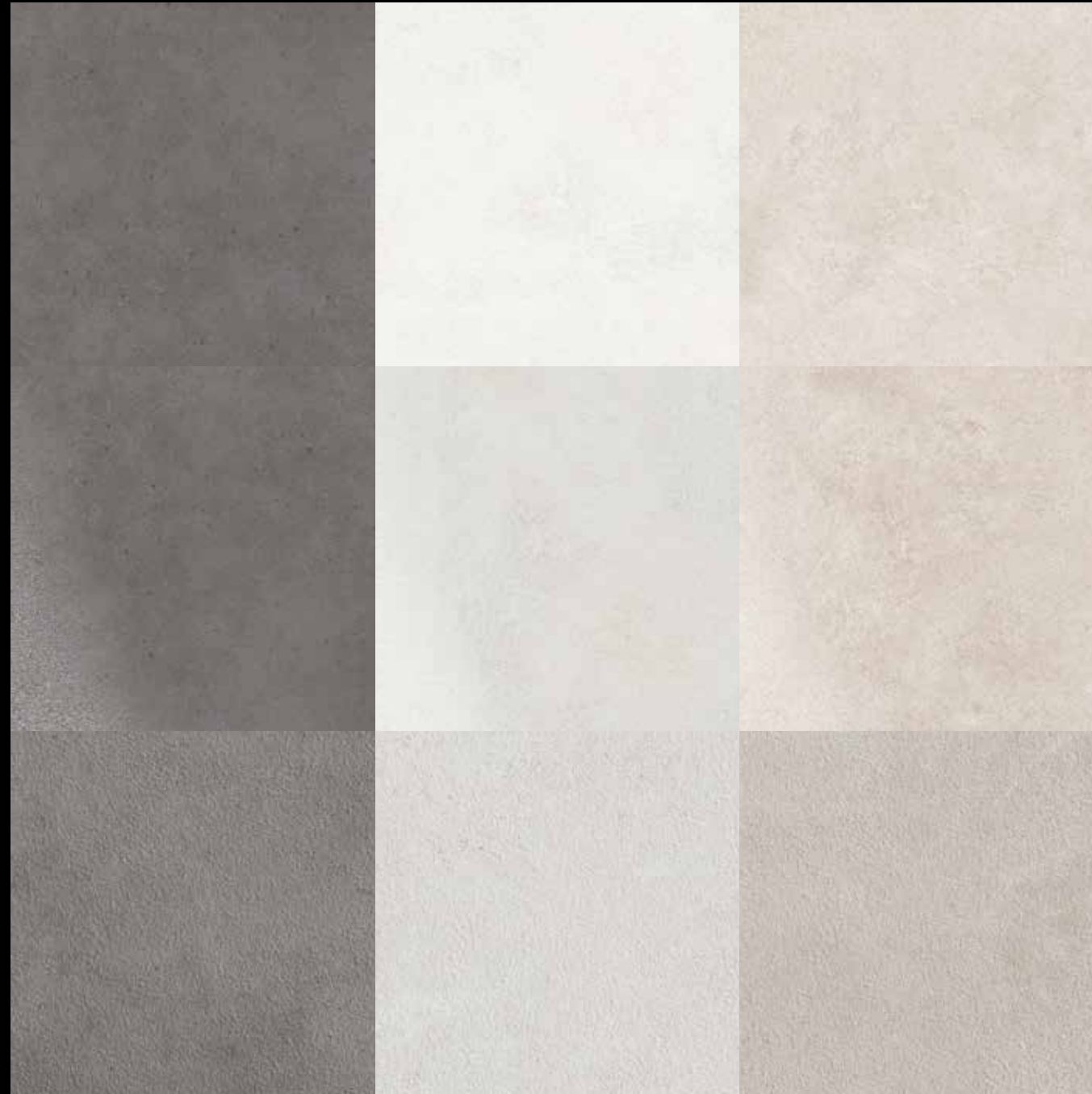

**R9**  
**NATURALE**  
 NATURAL / NATUR / NATURELLE / NATURAL

**LAPPATO**  
 HONED / LEICHT POLIERT / POLIADOUCI / PULIDO

**R10 A+B**  
**GRIP**  
 GRIP / GRIFFIGE OBERFLÄCHE / GRIP / ANTIDESLIZANTE



# ARCHISTONE *wallproject*

Gres fine porcellanato Bla UGL EN 14411 / Fine porcelain stoneware / Feinsteinzeug / Grès cérame fin / Gres fino porcelánico



**PENDULUM TEST BS 7976** Grip R10 A+B > 36 dry / < 25 wet  
Grip R11 A+B+C > 36 dry / > 36 wet

	Classement				
	U	P	E	C	Gel
60x120 Nat./Grip/Lapp.	U4	P3	E3	C2	S
30x120 Nat./Grip/Lapp.	U4	P3	E3	C2	S
60x60 Nat./Grip/Lapp.	U4	P4	E3	C2	S
30x60 Nat./Grip/Lapp.	U4	P4	E3	C2	S
30x30 Nat./Grip/Lapp.	U4	P4+	E3	C2	S

30x60 / 30x30 - 12"x24" / 12"x12"

## DECORO PIZZO 30x60 /12"x24" 4 pcs x box

## DECORO TRAMA 30x60 /12"x24" 4 pcs x box

## MOSAICO 30x30 /12"x12" 4 pcs x box

## MOSAICO 3D 30x60 /12"x24" 4 pcs x box

Grafite Rett.  
0050785



Grafite Rett.  
0050786

Grafite Rett.  
0050781



Grafite Lapp.  
0050782

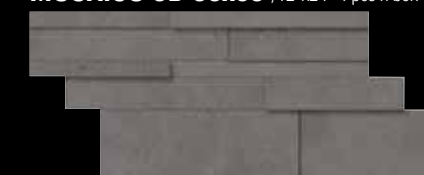

0050783 - Grafite Rett.

Limestone Bianco Rett.  
0050725



Limestone Bianco Rett.  
0050726

Limestone Bianco Rett.  
0050721

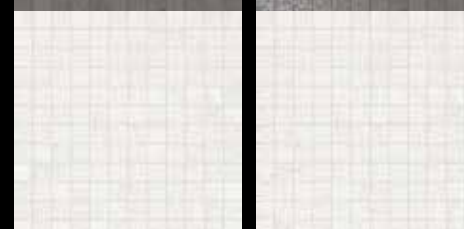

Limestone Bianco Lapp.  
0050722



0050723 - Limestone Bianco Rett.

Limestone Crema Rett.  
0050755



Limestone Crema Rett.  
0050756

Limestone Crema Rett.  
0050751

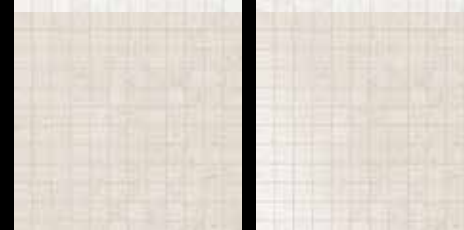

Limestone Crema Lapp.  
0050752



0050753 - Limestone Crema Rett.

Darkstone Rett.  
0050885



Darkstone Rett.  
0050886

Darkstone Rett.  
0050881



Darkstone Lapp.  
0050882



0050883 - Darkstone Rett.

Lightstone Rett.  
0050855



Lightstone Rett.  
0050856

Lightstone Rett.  
0050851



Lightstone Lapp.  
0050852



0050853 - Lightstone Rett.

Pietra di Bavaria Rett.  
0050821



Pietra di Bavaria Lapp.  
0050822



0050823 - Pietra di Bavaria Rett.

## DECORO DAMASCATO



Grafite Rett.  
0050784

Limestone Bianco Rett.  
0050724

Limestone Crema Rett.  
0050754

Darkstone Rett.  
0050884

# ARCHISTONE T20

Gres fine porcellanato Bla UGL EN 14411 / Fine porcelain stoneware / Feinsteinzeug / Grès cérame fin / Gres fino porcelánico



Grip R11 A+B+C > 0,60 dry / > 0,60 wet

PENDULUM TEST BS 7976 Grip R11 A+B+C > 36 dry / > 36 wet



**Posa sopraelevata su supporti regolabili**  
Installation using adjustable paving support



**Posa diretta su erba**  
Installation onto grass



**Posa diretta su ghiaia**  
Installation onto gravel



**Posa diretta su cemento**  
Installation onto cement

# TECH-INFO

PENDULUM TEST BS 7976

Grip R11 A+B+C > 36 dry / > 36 wet

**RESISTENZA ALLA FLESSIONE**  
FLEXION RESISTANCE

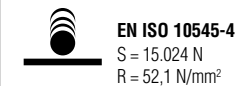

EN ISO 10545-4  
S = 15.024 N  
R = 52,1 N/mm<sup>2</sup>

**RESISTENZA ALL'URTO**  
IMPACT RESISTANCE

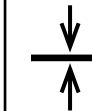

EN ISO 10545-5

**CARICO STATICO**  
STATIC LOAD



EN ISO 12825  
CENTRO - CENTRE = 7,75 kN  
CENTRO LATO - CENTRE POINT OF SIDE = 5,72 kN  
DIAGONALE - DIAGONAL = 7,24 kN

**Posa sopraelevata su supporti regolabili**  
Installation using adjustable paving support

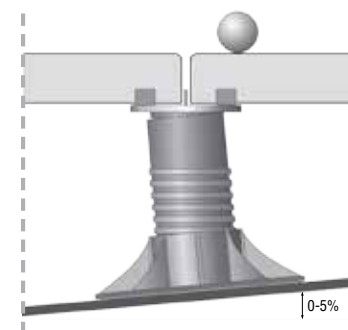

**SE**  
**Supporto regolabile con testa autolivellante**  
Adjustable paving support with self-levelling head



**NM**  
**Supporto regolabile**  
Adjustable paving support



**EH**  
**Supporto**  
Support

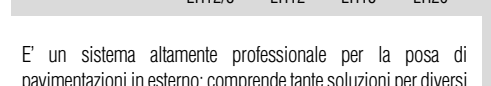

**SUPPORTI REALIZZATI IN METALLO TOTALMENTE RICICLABILE**  
SUPPORTS MADE FROM 100% RECYCLABLE MATERIAL

**RESISTENTI ALLE SOLUZIONI ACIDE E BASICHE**  
RESISTANT TO ACID AND ALKALI SOLUTIONS

**RESISTENTI AGLI AGENTI ATMOSFERICI**  
RESISTANT TO ATMOSPHERIC AGENTS

**RESISTENTI A TEMPERATURE DA -30° A +120°**  
RESISTANT TO TEMPERATURES FROM -30° TO +120°

**2,78 PCS**  
QUANTITÀ M<sup>2</sup>  
PIECES PER M<sup>2</sup>

**Posa diretta su erba**  
Installation onto grass

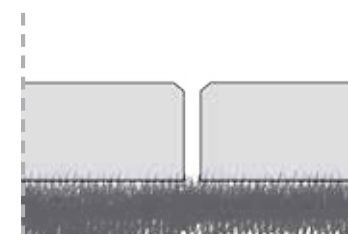

**Posa diretta su ghiaia**  
Installation onto gravel



**Posa diretta su cemento**  
Installation onto cement

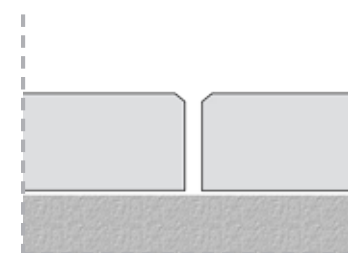

È un sistema altamente professionale per la posa di pavimentazioni in esterno: comprende tante soluzioni per diversi campi di applicazione, caratterizzate da facilità di montaggio e accompagnate da grande duttilità e adattabilità a tutte le esigenze progettuali. Lo spessore di 20 mm del gres porcellanato Archistone consente la perfetta planarità nella posa diretta su sottofondi in erba, cemento o ghiaia e nella posa sopraelevata su supporti regolabili e autolivellanti. Le elevate caratteristiche di resistenza e antiscivolo della finitura Grip garantiscono inalterabilità ed un'ottima durata nel tempo.

A highly professional system for the laying of outdoor flooring, it includes many solutions for various fields of application that stand out for their ease of assembly, great versatility and adaptability to all design needs. The 20 mm thickness of the Archistone porcelain guarantees perfect flatness when directly laid on grass, cement or gravel foundations, and installation using adjustable and self-levelling paving supports. The excellent resistance and non-slip qualities of the Grip finish guarantee excellent resilience and durability over time.

Ein professionelles System für die Verlegung von Bodenbelägen in Außenbereichen: Es umfasst zahlreiche Lösungen für verschiedene Anwendungsbereiche, die sich durch einfache Montage und eine große Projektflexibilität auszeichnen. Die 20 mm Stärke des Feinsteinzeugs Archistone gestatten eine völlig plane Verlegung direkt auf Untergründen wie Rasen, Beton oder Kies oder als Doppelboden auf höhenverstellbaren, selbstnivellierenden Stützen. Die ausgezeichnete Beständigkeit und Rutschhemmung der Oberfläche Grip gewährleisten eine hohe Langzeitqualität und lange Standzeit.

C'est un système hautement professionnel pour la pose de revêtements de sols en extérieur: ses multiples solutions, destinées à plusieurs domaines d'application, se caractérisent par une facilité de montage et une grande souplesse d'adaptation à toutes les exigences des projets. Avec une épaisseur de 20 mm, le grès cérame Archistone permet une planéité parfaite lors de la pose directe sur des sous-couches d'herbe, de béton ou de gravier, ou lors de la pose surélevée sur des supports réglables et autonivelants. La technicité élevée en termes de résistance et de qualité antidérapante de la finition Grip garantit inaltérabilité et excellente durée de vie.

Se trata de un sistema altamente profesional de colocación de pavimentos en exteriores: incluye numerosas soluciones, adecuadas para varios campos de aplicación, que se distinguen por la facilidad del montaje y por su gran ductilidad, que le permiten adaptarse a toda clase de exigencias proyectivas. El grosor de 20 mm del gres porcelánico Archistone permite una perfecta planicidad en la colocación directa sobre superficies de hierba, cemento o grava y en la colocación sobre elevada sobre soportes regulables y autonivelantes. Las notables características de resistencia y antideslizamiento del acabado Grip garantizan inalterabilidad y una extraordinaria durabilidad.

Tipo di supporto	Codice	Altezza supporto
SE1	A004000	da 37,5 a 50 mm
SE2	A004001	da 50 a 75 mm
SE3	A004002	da 75 a 120 mm
SE4	A004003	da 120 a 170 mm
SE5	A004004	da 170 a 215 mm
SE6	A004005	da 140 a 230 mm
SE7	A004006	da 185 a 275 mm
SE8	A004007	da 235 a 325 mm
SE9	A004008	da 205 a 345 mm
SE10	A004009	da 250 a 385 mm
SE11	A004010	da 300 a 400 mm
SE12	A004011	da 270 a 455 mm
SE13	A004012	da 315 a 500 mm
SE14	A004013	da 365 a 550 mm
NM1	A004014	da 25 a 40 mm
NM2	A004015	da 40 a 70 mm
NM3	A004016	da 60 a 100 mm
NM4	A004017	da 90 a 160 mm
NM5	A004018	da 150 a 270 mm
EH12/8	A004019	h 12 mm / ali h 8 mm
EH12	A004020	h 12 mm
EH15	A004021	h 15 mm
EH20	A004022	h 20 mm

**Equilibratore basculante**  
A004023



**Spessore livellatore**  
A004024



# ARCHISTONE

Gres fine porcellanato Bla UGL EN 14411 / Fine porcelain stoneware / Feinsteinzeug / Grès cérame fin / Gres fino porcelánico



**PENDULUM TEST BS 7976** Grip R10 A+B > 36 dry / < 25 wet  
Grip R11 A+B+C > 36 dry / > 36 wet

**ATM** Grip R10 A+B > 0,60 dry / > 0,60 wet  
Grip R11 A+B+C > 0,60 dry / > 0,60 wet

	Classement				
	U	P	E	C	Gel
60x120 Nat./Grip/Lapp.	U4	P3	E3	C2	S
30x120 Nat./Grip/Lapp.	U4	P3	E3	C2	S
60x60 - 30x30 Nat./Grip/Lapp.	U4	P4+	E3	C2	S
30x60 Nat./Grip/Lapp.	U4	P4	E3	C2	S

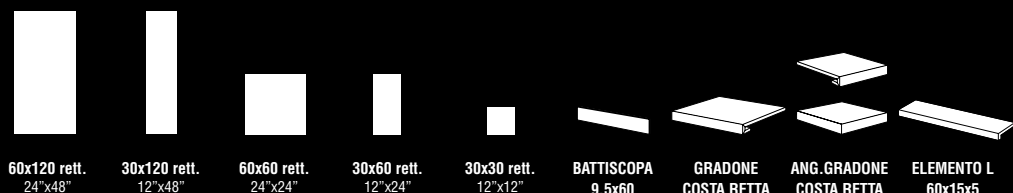

## NATURALE

NATURAL / NATUR / NATURELLE / NATURAL

	0050788	0051020	0050771	0050773	-	0050777	0050779	0050780	-
<b>Grafite</b>									
<b>Limestone Bianco</b>	0050728	0051000	0050711	0050713	-	0050717	0050719	0050720	-
<b>Limestone Crema</b>	0050758	0051010	0050741	0050743	-	0050747	0050749	0050750	-
<b>Darkstone</b>	0050888	0051050	0050871	0050873	0050875	0050877	0050879	0050880	-
<b>Lightstone</b>	0050858	0051040	0050841	0050843	0050845	0050847	0050849	0050850	-
<b>Pietra di Bavaria</b>	0050828	0051030	0050811	0050813	0050815	0050817	0050819	0050820	-

## LAPPATO

HONED / LEICHT POLIERT / POLI ADOUCI / PULIDO

	0050789	0051021	0050772	0050774	-	0050778	-	-	-
<b>Grafite</b>									
<b>Limestone Bianco</b>	0050729	0051001	0050712	0050714	-	0050718	-	-	-
<b>Limestone Crema</b>	0050759	0051011	0050742	0050744	-	0050748	-	-	-
<b>Darkstone</b>	0050889	0051051	0050872	0050874	0050876	0050878	-	-	-
<b>Lightstone</b>	0050859	0051041	0050842	0050844	0050846	0050848	-	-	-
<b>Pietra di Bavaria</b>	0050829	0051031	0050812	0050814	0050816	0050818	-	-	-

## GRIP

GRIP SURFACE / SURFACE GRIP / GRIFFIGE OBERFLÄCHE / SUPERFICIE ANTIDESLIZANTE

	0050797	0051022	0050791	0050792	-	-	-	-	0050795
<b>Grafite</b>									
<b>Limestone Bianco</b>	0050737	0051002	0050731	0050732	-	-	-	-	0050735
<b>Limestone Crema</b>	0050767	0051012	0050761	0050762	-	-	-	-	0050765
<b>Darkstone</b>	0050897	0051052	0050891	0050892	0050893	-	-	-	0050895
<b>Lightstone</b>	0050867	0051042	0050861	0050862	0050863	-	-	-	0050865
<b>Pietra di Bavaria</b>	0050837	0051032	0050831	0050832	0050833	-	-	-	0050835

## GRIP 2MM

GRIP SURFACE / SURFACE GRIP / GRIFFIGE OBERFLÄCHE / SUPERFICIE ANTIDESLIZANTE

	-	-	0050799	-	-	-	-	-	-
<b>Grafite</b>									
<b>Limestone Bianco</b>	-	-	0050739	-	-	-	-	-	-
<b>Limestone Crema</b>	-	-	0050769	-	-	-	-	-	-
<b>Darkstone</b>	-	-	0050899	-	-	-	-	-	-
<b>Lightstone</b>	-	-	0050869	-	-	-	-	-	-
<b>Pietra di Bavaria</b>	-	-	0050839	-	-	-	-	-	-

## IMBALLI

PACKING / VERPACKUNGEN / EMBALLAGES / EMBALAJES

Formato	Pezzi/Sc.	Mq/Sc	Sc/Pal	Mq/Pal	Kg/Sc	Kg/Pal
Size	Pcs/Box	Sq./M/Box	Box/Pal	Sq./M/Pal	Kg/Box	Kg/Pal
Größe	Pcs/Ctn	Mq/Ctn	Ctn/Pal	Mq/Pal	Kg/Ctn	Kg/Pal
Format	Stck/Kart	Qm/Kart	Kart/Pal	Qm/Pal	Kg/Kart	Kg/Pal
Tamaño	Piezas/Caja	Mq/Caja	Caja/Pal	Mq/Pal	Kg/Caja	Kg/Pal
<b>60x120</b>	<b>2</b>	<b>1,44</b>	<b>20</b>	<b>28,80</b>	<b>36,00</b>	<b>720,0</b>
<b>30x120</b>	<b>2</b>	<b>0,72</b>	<b>36</b>	<b>25,92</b>	<b>18,00</b>	<b>648,0</b>
<b>60x60</b>	<b>3</b>	<b>1,08</b>	<b>32</b>	<b>34,56</b>	<b>25,50</b>	<b>816,0</b>
<b>60x60 sp. 20mm</b>	<b>2</b>	<b>0,72</b>	<b>32</b>	<b>23,04</b>	<b>32,50</b>	<b>1040,0</b>
<b>30x60</b>	<b>6</b>	<b>1,08</b>	<b>32</b>	<b>34,56</b>	<b>25,60</b>	<b>819,2</b>
<b>30x30</b>	<b>11</b>	<b>0,99</b>	<b>40</b>	<b>39,60</b>	<b>22,50</b>	<b>900,0</b>

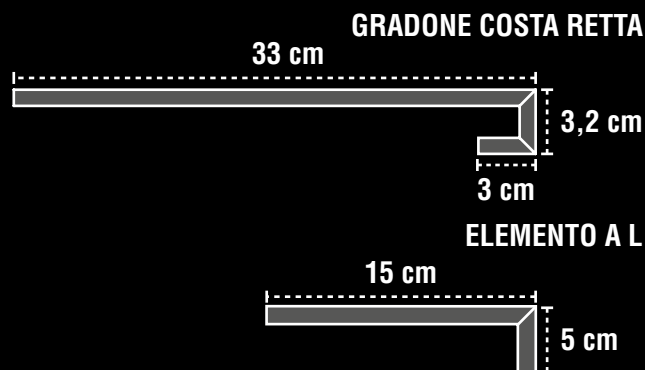

MATERIALI PROGETTATI PER USO COMMERCIALE E RESIDENZIALE / MATERIALS DESIGNED FOR USE IN RESIDENTIAL AND COMMERCIAL AREAS / FÜR WOHN-UND GESCHÄFTSBEREICHE ENTWORFENES MATERIA / MATÉRIAUX PROJÉTÉ POUR BÂTIMENTS RÉSIDENTIELS ET POUR ESPACES COMMERCIAUX / MATERIALES DISEÑADOS PARA USO EN ÁREAS RESIDENCIALES Y ESPACIOS COMERCIALES

Caratteristica Features Características Eigenschaften Características	Unità di misura Unit of measurement Unité de mesure Masseinheit Unidad de medida	Valore medio Areatech Areatech mean value Valeur moyenne Areatech Durchschnitts-wert-Areatech Valor medio Areatech	Valore Prescritto Fixed value Valeur prescrite Vorgeschriebener wert Valor establecido	Metodo di prova Test method Méthode d'essai Prüfmethode Método de ensayo
Dimensione lati Dimensions-Lenght and widht Masse-Länge und Breite Dimensions-Longueur et largeur Dimensiones-Longitud y ancho	%	Conforme Conform Gleichmässig Conforme Conforme	+/- 0.6 MAX +/-2.0 mm	UNI EN ISO 10545-2
Rettilineità dei lati Side straightness Gerachlinigkeit der Kanten Rectitude des arêtes Rectilinedad de los lados	%	Conforme Conform Gleichmässig Conforme Conforme	+/- 0.5 MAX +/- 1.5 mm	UNI EN ISO 10545-2
Ortogonalità degli spigoli Corner squaranness Rechtwinkligkeit der Kanten Angularité Ortogonalidad de las esquinas	%	Conforme Conform Gleichmässig Conforme Conforme	+/- 0.5 MAX +/- 2.0 mm	UNI EN ISO 10545-2
Planarità Flatness Ebenflächigkeit Planéité Planeidad	%	Conforme Conform Gleichmässig Conforme Conforme	+/- 0.5 MAX +/- 2.0 mm	UNI EN ISO 10545-2
Spessore Thickness Dicke Épaisseur Grosor	%	Conforme Conform Gleichmässig Conforme Conforme	+/- 5 MAX +/- 0.5 mm	UNI EN ISO 10545-2
Assorbimento d'acqua Water absorption Wasseraufnahme Absorption d'eau Absorción de agua	%	Conforme Conform Gleichmässig Conforme Conforme	≤ 0,5	UNI EN ISO 10545-3
Resistenza all'abrasione profonda Resistance to abrasion Beständigkeit gegen oberflächenverschleiss Résistance à l'abrasion Resistencia à la abrasión	MM³	Conforme Conform Gleichmässig Conforme Conforme	≤ 175	UNI EN 10545-4
Resistenza al gelo Frost resistance Frostbeständigkeit Résistance au gel Resistencia al hielo	-	Resiste Resists Widerstandsfähig Résiste Resiste	Richiesta Request Onfrange Demande Solicitud	UNI EN ISO 10545-12
Sforzo di rottura Breaking strenght Bruchkraft Contrainte de rupture Estuerzo de rotura	N	Conforme Conform Gleichmässig Conforme Conforme	≥ 1300 se sp ≥ 7,5 mm ≥ 700 se sp < 7,5 mm	UNI EN ISO 10545-4
Modulo di rottura Modulus of rupture Bruchmodul Coefficient de rupture Módulo de rotura	N/mm²	Conforme Conform Gleichmässig Conforme Conforme	≥ 35	UNI EN ISO 10545-4
Dilatazione termica lineare Coeff. of linear thermal expansion Linearer wärmeausdehnungs-koeffizient Coeff. d'extension thermique linéaire Coeficiente de dilatación térmica lineal	°MK (-1)	7,0	-	UNI EN ISO 10545-8
Resistenza ai prodotti chimici di uso domestico Resistance to chemicals for household use Beständigkeit gegen haushaltschemikalien Resistance aux produits d'usage domestique Resistencia a los productos químicos de uso doméstico	-	Conforme Conform Gleichmässig Conforme Conforme	UB	UNI EN ISO 10545-13
Resistenza agli sbalzi termici thermal shock resistance widerstandsfähigkeit gegen temperaturschwankungen résistance aux écarts de température resistencia al choque térmico	-	Conforme Conform Gleichmässig Conforme Conforme	Richiesta Request Onfrange Demande Solicitud	UNI EN ISO 10545-9
Stabilità dei colori Colour stability Lichtechtheit der färbung Stabilité des coloris Estabilidad de los colores	-	Resiste Resists Widerstandsfähig Résiste Resiste	Richiesta Request Onfrange Demande Solicitud	DIN 51094



Uffici commerciali:  
Via Statale, n° 99/D  
42013 Dinazzano di Casalgrande - RE  
Tel. +39 0522 773.611  
Fax +39 0522 773.659/60  
[ceramichecerdisa.it](http://ceramichecerdisa.it)  
[marketing@ceramichecerdisa.it](mailto:marketing@ceramichecerdisa.it)